



**RAM<sup>®</sup>**  
**MOUNTS**

Powersports



# about RAM<sup>®</sup> Mounts

RAM<sup>®</sup> Mounts manufactures rugged and versatile mounting systems for cameras, tablets and other mobile devices that can be attached nearly anywhere. Unlike other mounts on the market, RAM<sup>®</sup> allows you to mount items where you need them most. The unique design of the RAM<sup>®</sup> Mounts system provides quick installation, adjustability, strength, vibration dampening and durability, all at a low cost. RAM<sup>®</sup> uses marine grade aluminum with a powder-coated finish, light-weight and high-strength composites, stainless steel hardware and nitrile rubber balls. All made in the USA and backed by a lifetime warranty.

## the RAM<sup>®</sup> difference



### Lifetime Warranty

RAM<sup>®</sup> products are backed by a lifetime warranty against manufacturer's defect for decades of worry-free use.

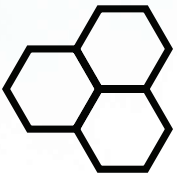

### Modular Design

The rubber ball and socket design offers a secure hold with vibration dampening and component interchangeability.

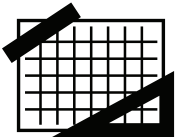

### Designed & Developed in House

Each RAM<sup>®</sup> Mount is designed in house using the most advanced industry techniques.



### Made in the USA

Every single RAM<sup>®</sup> Mount is manufactured in the USA with an attention to detail and quality.



### 3-D Printing

RAM<sup>®</sup> is a pioneer in using 3-D printing technology to develop and test new prototypes.



### Aluminum Die Casting & Injection Molding

RAM<sup>®</sup> Mounts are made to last a lifetime with the highest quality aluminum, composites, and other materials.

# our partners

**Customer Focus.** RAM® owes its success to loyal customers like you. RAM® products are incredibly robust, functional and set the standard for military, commercial, consumer and industrial applications. In addition, RAM® offers mounting solutions so compact and light that they have become a favorite with powersports enthusiasts.

**OEMs Trust RAM®.** RAM® Mounts isolate and dampen harmful shock and vibration. OEMs know that pairing their products with RAM® means their products will perform better and last longer in a wide range of applications and environments.

**Safe, Secure Mounting.** RAM® Mounts help you get the most out of your devices and your activities. The unique rubber ball and socket design prevents slippage while protecting your device from harmful shock in high vibration situations.

**Fit to Your Needs.** With thousands of mounting configurations to choose from, RAM® is sure to have the ideal solution for your device mounting needs. Trust in RAM® to offer you the most versatile and robust mounting solution available.



# table of contents

Bases .....	6
Arms .....	14
Camera Adapters .....	16
Cradle/Device Adapters .....	18
Cradles .....	20
Complete Kits .....	26
Accessories .....	34
IntelliSkin™ with GDS Tech™ .....	38
All Products .....	44



# how it works

## Choose a base.

Choose from a variety of bases to help secure your device where you need it.

## Choose an arm.

Choose an arm based on your desired length and placement.

## Choose a cradle.

RAM® offers a wide selection of holders and cradles for your specific device.



# bases

**seen in this photo:**

RAM-B-231CHU (chrome u-bolt)

RAM-B-201CHU (chrome standard arm)

RAM-HOL-UN10BU (X-Grip® for larger phones)

RAM-HOL-UN10TU (security tether for larger phones)



## Handlebar Base with Zinc-Coated U-Bolt

This base has a 1" diameter rubber ball designed to sit at right angles to the mounting rail. The zinc-coated u-bolts accommodate rails from .5" to 1.25" in diameter. Black caps are included to cover the exposed ends of the u-bolt and a composite adapter can narrow the minimum diameter of the rail to .5".



Standard Part:	RAM-B-231ZU
U-bolt material:	zinc-coated
Chrome Part:	RAM-B-231CHU
U-bolt material:	stainless steel
Fits Handlebars:	.5" - 1.25" diameter
Included Hardware:	adapter, 2 u-bolts, nuts, cover caps
Ball Size:	1" diameter rubber ball



\*chrome part seen in image on page 6

## Flat Base with 11mm Hole

This marine grade, powder-coated aluminum base is 2.25" long .875" wide x .2" thick with a 1" diameter rubber ball and 11mm hole. The versatile flat base can be attached to the mirror frame and fits well on exposed bolts.



Part:	RAM-B-252U
Hole Size:	11mm diameter hole
Ball Size:	1" diameter rubber ball



## Angled Base with 9mm Hole

This marine grade, powder-coated aluminum base has a 1" diameter ball and 9mm hole. The size of the bolt-down area is 1.1875" long x .75" wide x .2" thick and the ball sits at a 30 degree angle. This angled base is often attached to the mirror frame and fits well on exposed bolts.



Part:	RAM-B-272U
Hole Size:	9mm diameter hole
Ball Size:	1" diameter rubber ball





## Handlebar/Brake/Clutch Reservoir Base

The combination handlebar and brake/clutch reservoir base provides the ultimate flexibility for mounting to your motorcycle. The kit contains standard and metric threaded stainless bolts as well as zinc-coated metal u-bolts accomodating .5" to 1.25" diameter rails.

Standard Part:	RAM-B-309-7U
Chrome Part:	RAM-B-309-1CHU (u-bolts not included)
U-Bolt Fits:	.5" - 1.25" diameter rails
Hole Centers:	.94" min. - 1.58" max. width
Included Hardware:	stainless bolts, zinc-coated u-bolts, nylock nuts
Ball Size:	1" diameter rubber ball



## Handlebar Clamp Base with M8 Screws

This 1" rubber ball base will replace an M8 by 25, 30, or 35mm handlebar bolt. To determine compatibility, measure the bolt diameter and add 30mm to the length. Screw the ball base onto the handlebar top clamp using one of the three included 1.25mm thread pitch bolts: M8 x 55mm, M8 x 60mm and M8 x 65mm.

Part:	RAM-B-367U
Included Hardware:	3, 1.25mm thread pitch bolts sizes: M8 x 55, M8 x 60 and M8 x 65
Ball Size:	1" diameter rubber ball



## Fork Stem Base

The fork stem base is designed to fit and expand into the cylindrical bore wall of fork stems and will work with stems that measure 12, 14, 16, 18 and 20mm (.5", .55", .63", .71" and .79") wide. The base is made of powder-coated, marine grade aluminum and includes a 1" diameter rubber ball.

Part:	RAM-B-342U
Works w/ fork stem inner diameter:	12, 14, 16, 18 & 20mm .5", .55", .63", .71" & .79"
Included Hardware:	expansion plug, screw and washer set, plastic washers
Ball Size:	1" diameter rubber ball





## Brake/Clutch Reservoir Cover Base

This base fits over your existing brake/clutch reservoir cover with the 1" ball offset. Made of die cast aluminum with a 1" diameter rubber ball, the mount is shaped to fit above the cover using existing screw holes and longer screws provided. The center slots are 2 7/16" center-to-center. The plate dimensions are 3.5" long x 1.75" wide.



Part:	RAM-B-346U
Slot Spacing:	2 7/16" center to center
Slot Size:	1/2" long slots
Included Hardware:	4 nylon spacers, 3 screw sets: M4 x 20, M4 x 30 and M4 x 35
Ball Size:	1" diameter rubber ball



## Gas Tank Filler Cap Base

This base is a low-profile way to get a unique perspective from your camera or to attach your electronic device where it can be quickly accessible. We include the hardware you need to mount to the fill port for stock tanks on most popular makes such as Yamaha, Suzuki, Kawasaki, BMW and Honda.



Part:	RAM-B-410U
Compatible Bikes:	Honda, Suzuki, Yamaha, Victory, KTM
Included Hardware:	M6 x 25, M5 x 16, M5 x 20, M5 x 25, M5 x 35, M5 x 45 screws
Part:	RAM-B-411U
Compatible Bikes:	BMW, Kawasaki
Included Hardware:	M5 x 25 and M5 x 40 screws
Ball Size:	1" diameter rubber ball



## Mirror Post Base for Harley-Davidson

This low-profile mounting base is designed to mount directly through the mirror holes on a standard Harley-Davidson. It has a threaded bolt and we include a barrel nut that enables you to mount the ball on top or below the hand grips where the mirror holes are located. This helps ensure a clear line of site.



Part:	RAP-B-379-HA1U
Thread Size:	1/4"-20 x 1"
Included Hardware:	female blind barrel nut & nylon washer
Ball Size:	1" diameter rubber ball



## Tough-Claw™

The RAM® Tough-Claw™ is the perfect mounting base for quick installation and removal on round, square and odd-shaped rails and bars such as handlebars or roll cages. The Tough-Claw™ can be clamped on rails .625" to 2.25" in diameter. This versatility makes the Tough-Claw™ ideal for mounting tablets, action cameras, smartphones and much more in a wide variety of applications.



### Small Tough-Claw™

Part:	RAP-B-400U
Clamping range (rail):	.625" - 1.5" diameter
Ball Size:	1" diameter rubber ball

*\*seen in image on page 11*



### Medium Tough-Claw™

Part:	RAP-B-404U
Clamping range (rail):	1" - 1.875" diameter
Ball Size:	1" diameter rubber ball



### Large Tough-Claw™

Part:	RAP-B-401U
Clamping range (rail):	1" - 2.25" diameter
Ball Size:	1" diameter rubber ball



seen in this photo:  
RAP-B-400U (small Tough-Claw™)  
RAM-B-201U (standard arm)  
RAP-B-202U-GOP1 (GoPro® adapter)



## Torque™ Handlebar Bases

RAM® Mounts' new Torque™ bases fit a variety of rail and bar sizes for secure placement of your device. Sizing inserts create a tight hold while protecting the bar. The cast aluminum mount is available with a 1" or 1.5" rubber ball that attaches to a RAM® arm. Mount your GPS unit, camera, phone or tablet to handlebars, roll cages or even mirror posts. The possibilities are endless!



Parts:	Fits Rails:	Ball Size:
RAM-B-408-112-15U	1.125" - 1.5" diameter	1" diameter
RAM-408-112-15U	1.125" - 1.5" diameter	1.5" diameter
RAM-B-408-75-1U	.75" - 1" diameter	1" diameter
RAM-408-75-1U	.75" - 1" diameter	1.5" diameter
RAM-B-408-37-62U	.375" - .625" diameter	1" diameter

\* RAM-B-408-75-1U seen in image on page 12

\* RAM-B-408-37-62U seen in image on page 13

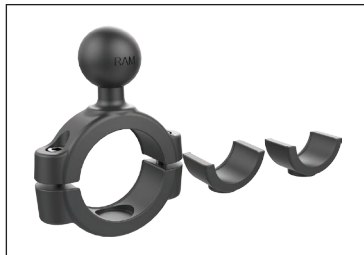

seen in this photo:  
RAM-B-408-75-1U (Torque™ handlebar base)



seen in this photo:  
RAM-B-408-37-62U (Torque™ handlebar base)  
RAM-B-201U-A (short arm)  
RAM-HOL-UN7BU (X-Grip® for phones)  
RAM-HOL-UN7TU (security tether for phones)



## Short Double Socket Arm for 1" Balls

The short double socket arm has a socket at both ends that accommodates 1" ball bases. RAM® ball and socket technology allows for almost infinite adjustment and perfect viewing angles. With a length of 2.38", this arm is great when you need to mount your device close to your motorcycle or vehicle.

Standard Part:	RAM-B-201U-A
Chrome Part:	RAM-B-201-ACHU
Dimensions:	2.38" overall length
Socket Spacing:	1.75" socket to socket
Fits:	1" diameter balls



*\*seen in image on page 15*



## Standard Double Socket Arm for 1" Balls

The standard double socket arm has a socket at both ends that accommodates 1" ball bases. A single spring inside the arm opens the end sockets, allowing you to pivot the ball and socket connection. Our most popular arm, the 3.69" length provides flexibility for a variety of mounting applications.

Standard Part:	RAM-B-201U
Chrome Part:	RAM-B-201CHU
Dimensions:	3.69" overall length
Socket Spacing:	3" socket to socket
Fits:	1" diameter balls

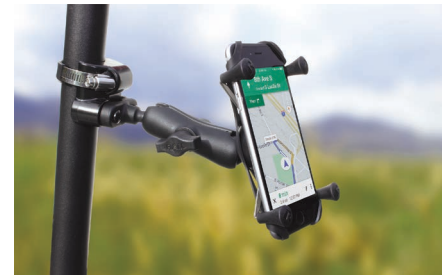

## Multi Pivot Arm for 1" Balls

The multi pivot arm consists of two 1" diameter open ball sockets with a 360 degree rotation point at the center. It also features a connecting swivel joint that rotates forward and back 180 degrees. The socket at either end and a central pivot point provides unsurpassed adjustability.

Part:	RAP-B-200-2U
Dimensions:	6.25" overall length
Socket Spacing:	5.5" socket to socket
Adjustability:	360° rotation points 180° connecting swivel point
Fits:	1" diameter balls



**seen in this photo:**

RAM-B-404U (medium Tough-Claw™)

RAM-B-201U-A (short arm)

RAM-B-238U (diamond adapter base)



# camera adapters



## Adapter for GoPro® HERO Cameras

The RAM® adapter for GoPro® HERO consists of a 1" diameter rubber ball connected to a custom GoPro® adapter. The adapter attaches directly to the under-side of the protective case replacing the factory mounting bracket. This mount connects to the RAM® ball and socket system to dampen vibration and add durability.

Part:	RAP-B-202U-GOP1
Fits:	GoPro® HERO cameras
Ball Size:	1" diameter rubber ball



## Round Base with 1/4\"-20 x .25\" Stud

The universal camera base has a 1" diameter rubber ball with a 2.5" diameter round plate and a 1/4"-20 camera thread. The round plate provides extra support and stability for cameras that rest on top of it. The threaded stainless steel stud will connect to any standard camera.

Part:	RAM-B-202AU
Dimensions:	2.5" diameter round plate
Stud dimensions:	1/4"-20 x .25" male threaded post
Ball Size:	1" diameter rubber ball



## Tough-Ball™ Base with 1/4\"-20 x .25\" Stud

The Tough-Ball™ camera base consists of a 1" diameter rubber ball, connected to a 1/4"-20 x .25" threaded post. The post matches most standard camera female threads found on the bottom of the camera. This mount is a durable way to secure smaller cameras using the RAM® ball and socket system.

Part:	RAP-B-379U-252025
Stud dimensions:	1/4"-20 x .25" male threaded post
Ball Size:	1" diameter rubber ball





# camera adapters

**seen in this photo:**

RAP-B-401U (large Tough-Claw™)

RAM-B-201U (standard arm)

RAP-B-366U (1" ball w/ 1/4"-20 stud for cameras)



# cradle/device adapters

## Round Ball Base with AMPs Pattern



This 2.5" round base has seven different holes that are compatible with any AMPs pattern accessory. You also have the versatility to mount your device permanently onto your ATV, side by side or motor-cycle by using this as a drill-down base. This mount connects to any device holder containing the universal AMPs pattern.

Part:	RAM-B-202U
Dimensions:	2.5" diameter
Hole Pattern:	1.5" x 1.188" AMPs hole pattern and 3 holes at 120 degrees
Ball Size:	1" diameter rubber ball



## Diamond Ball Base



The diamond ball base is a versatile mounting component that attaches to many of RAM® Mounts device holders such as our EZ-Roll'r™ cradles. The two-hole base attaches securely anywhere you want to have access to your device and can be used as a low-profile permanent mounting solution.

Part:	RAM-B-238U
Dimensions:	2.43"l x 1.31"w
Hole Pattern:	2 holes, 1.912" center to center matches cross section of the AMPs hole pattern
Ball Size:	1" diameter rubber ball

*\*seen in image on page 19*



## Square Ball Base with AMPs Pattern



The square base connects to device holders with the universal AMPs hole pattern and can be used to attach directly to devices containing this hole pattern. This adapter can attach to many devices including GPS units and tuners.

Part:	RAM-B-347U
Dimensions:	2"l x 1.7"w
Hole pattern:	1.5" x 1.188" AMPs hole pattern
Ball Size:	1" diameter rubber ball



# cradle/device adapters

seen in this photo:

- RAM-B-231ZU (rail base w/ zinc-coated u-bolt)
- RAM-B-201U-A (short arm)
- RAM-B-238U (diamond base)
- RAM-HOL-AP18U (form-fitted cradle for iPhone 6)



## Adapter Guide: Select your cradle adapter

We give you the choice to fully customize your mounting system. Each component is modular and as part of building the perfect solution for your needs, you will need to choose a cradle adapter that will mount to your cradle and connect to the arm of your choice. Select from diamond or round ball adapters.

**Round Base,  
1" ball**



Part: RAM-B-202U

**Chrome Round  
Base, 1" ball**



Part: RAM-B-202CHU

**Round Base,  
1.5" ball**



Part: RAM-202U

**Diamond Base,  
1" ball**



Part: RAM-B-238U

**Chrome Diamond  
Base, 1" ball**



Part: RAM-B-238CHU



## Universal Vehicle Phone Dock with GDS™ Technology for RAM® Intelliskin™ Products

The RAM® universal vehicle phone dock with GDS™ Technology is a spring-loaded, quick release cradle that offers a secure fit with easy access to the mounted phone or phablet. This docking station is compatible with any phone or phablet wrapped in IntelliSkin™ and provides an integrated charging system.

Part:	RAM-GDS-DOCK-V1U
Hole Pattern:	2 holes, 1.912" center to center matches cross section of the AMPs hole pattern
Fits:	any phone in an IntelliSkin™
Included Hardware:	nuts & bolts



## Form-Fitted Cradle for the Apple iPhone 6

This high-strength composite cradle secures your iPhone with a low-profile design that attaches to RAM® components. This cradle only fits devices without a case and maintains access to the phone's camera and other functionality. The cradle has a cutout to ensure the charging cord can still be used while your phone is mounted.

Part:	RAM-HOL-AP18U
Hole Pattern:	2 holes, 1.912" center to center matches cross section of the AMPs hole pattern
Fits:	iPhone 6 & 6s
Included Hardware:	nuts & bolts





## Spring-Loaded Cradle for Cell Phones

This spring-loaded cradle is designed to hold a variety of cell phones and small electronic devices. This cradle contains adjustable side clamps that close tightly on the item you want to hold. The spring-loaded hook expands and contracts, which provides ultimate security for all of your mobile devices.

Part:	RAM-HOL-PD3U
Clamping Height Range:	4.75"-6.25"
Clamping Width Range:	2.25"-3.25"
Hole Pattern:	2 holes, 1.912" center to center matches cross section of the AMPs hole pattern
Included Hardware:	nuts & bolts



## Universal Finger-Grip™ Phone/Radio Cradle

This versatile mount features three sets of sturdy flexible fingers that wrap around the device to secure it into the cradle, even in the roughest terrain. This cradle is designed to keep radios, GPS devices, phones and other electronics at your finger tips.

Part:	RAM-HOL-UN4U
Plate Dimensions:	2.5" w x 5" l
Height Dimensions:	5.25" min - 6" max. w/ top and bottom plates
Short Arm Clamps:	1.35" - 3" wide, max depth .75"
Medium Arm Clamps:	1.5" - 3.5" wide, max depth 1.25"
Long Arm Clamps:	2.25"-3.5" wide, max depth 1.6"
Hole Pattern:	2 holes, 1.912" center to center AMPs hole pattern, 1.5" x 2" pattern
Included Hardware:	nuts, bolts & rubber arm covers



## Self-Leveling Cup Holder

The perfect accessory for motorcycles and ATVs. Designed to keep your favorite beverage within reach, this gem even comes with a RAM® can insulator. Take a corner as hard as you like, this holder is ready to ride and will keep your beverage of choice upright. The integrated eyelet and hooks provides a tether attachment point.

Part:	RAM-B-132BU
Fits:	Cups, cans, bottles or mugs 2.5" - 3.5" diameter
Ball Size:	1" diameter rubber ball





## EZ-Roll'r™ Cradle for SPOT Gen3™

This small device can lead help right to wherever you might need it. Keeping it secure and inconspicuous is crucial when you're out exploring new terrain or home waters. The high-strength composite cradle is molded for the SPOT Gen3™ device and mounts to any RAM® Mounts ball and socket component.

Part:	RAM-HOL-SPO4U
Hole Pattern:	2 holes, 1.912" center to center matches cross section of the AMPs hole pattern
Fits:	Spot Gen3™
Included Hardware:	nuts & bolts



## EZ-Roll'r™ Cradle for Garmin Montana®

The Garmin Montana® is a big, tough outdoor GPS that features a 5mp camera. The EZ-Roll'r™ cradle is a big, tough cradle that keeps the Montana® secure and provides access to the camera. Snap the GPS into the cradle and capture the memories as you explore your favorite spots that you didn't know exist.

Part:	RAM-HOL-GA46U
Hole Pattern:	2 holes, 1.912" center to center matches cross section of the AMPs hole pattern
Fits:	Garmin Montana® 600, 650 & 650t
Included Hardware:	nuts & bolts



## Cradle For The Garmin nüvi® 65, 66, 67, 68

This secure mount for Garmin nüvi® GPS units will help you find your way. Go ahead and get lost in the adventure of the open road. The roller mount cradle snaps the GPS in securely and provides access ports for the power cable and speaker. This will secure to any RAM® Mount ball and socket arm.

Part:	RAM-HOL-GA67U
Hole Pattern:	2 holes, 1.912" center to center matches cross section of the AMPs hole pattern
Fits:	Garmin nüvi® 65LM, 65LMT, 66LM, 66LMT, 67LM, 67LMT, 68LM, 68LMT
Included Hardware:	nuts & bolts



seen in this photo:

RAM-B-231ZU (rail base w/ zinc-coated u-bolt)

RAM-B-201U-C (long arm)

RAM-B-347U (square adapter base)



# cradles



seen in this photo:  
RAM-B-408-75-1U (Torque™ handlebar base)  
RAM-B-201U (standard arm)  
RAM-HOL-UN8BU (X-Grip® for 7" tablets)  
RAM-HOL-UN8TU (security tether for 7" tablets)



## X-Grip® Universal Phone Holder

If you are looking for a compact mount for your cell phone, you've found it. The RAM® X-Grip® has a clean and clever four leg design that sports great holding power without hiding your phone. The patented grips keeps your device in plain view so you can access your GPS or camera. Compatible and interchangeable with a wide range of popular RAM® Mount products, this elegant cradle is ready to compliment your phone and become the most useful accessory in your vehicle.

The X-Grip® includes a device tether intended for rugged use.



Part:	Fits:	Minimum Width:	Maximum Width:	Ball Size:
RAM-HOL-UN7BU	phones	1.875"	3.25"	1" diameter
RAM-HOL-UN10BU	larger phones	1.75"	4.5"	1" diameter
RAM-HOL-UN8BU	7" - 8" tablets	2.5"	5.75"	1" diameter



## How to use the X-Grip®:

- 
- 
- 



# complete kits

**seen in this photo:**

RAM-B-176-A-UN7U (kit including fork stem mount with universal X-Grip® phone cradle)



## Fork Stem Mount with Universal X-Grip® Phone Cradle



We've paired the X-Grip® with an insert that secures the cradle and arm into your fork stem. The included fork stem base is designed to fit into the cylindrical bore wall of fork stems with openings that measure 12, 14, 16, 18, 20, and 28mm (.5", .55", .63", .71", .79" and 1.10") wide. The RAM® X-Grip® has a clean and clever four leg design that sports great holding power without hiding your phone behind foam pads and plastic. The patented grips keep your device in plain view so you can access your GPS or camera. The X-Grip® includes a device tether intended for rugged use.

Part:	RAM-B-176-A-UN7U
Works w/ fork stem inner diameters:	12, 14, 16, 18, 20 & 28mm .5", .55", .63", .71", .79" & 1.10"
Included Hardware:	expansion plug, screw and washer set, plastic washers
Ball Size:	1" diameter rubber ball

X-Grip®	Dimensions:
Width:	1.875" - 3.25"
Height:	2.25" - 4.25"
Depth:	.875"

Included Components:	
RAM-HOL-UN7BU	X-Grip®
RAM-B-201U-A	short arm
RAM-B-342U	fork stem base
RAM-HOL-UN7TU	tether

*\*seen in image on page 26*

## Brake/Clutch Reservoir U-Bolt Mount with Universal X-Grip® Phone Cradle



Use this kit to mount to either brake/clutch reservoirs or rails that are .5" to 1.25" in diameter with the included zinc-coated metal u-bolts. The mounting hardware for reservoirs include both standard and metric mounting bolts for use with brake/clutch reservoirs with hole centers .94" - 1.58". The RAM® X-Grip® has a clean and clever four leg design that sports great holding power without hiding your device. The patented grips keep your device in plain view so you can access your GPS or camera. The X-Grip® includes a device tether intended for rugged use.

Part:	RAM-B-174-UN7U
U-Bolt Fits:	.5" - 1.25" diameter rails
Hole Centers:	.94" min. - 1.58" max. width
Included Hardware:	stainless bolts, zinc-coated u-bolts, nylock nuts
Ball Size:	1" diameter rubber ball

X-Grip®	Dimensions:
Width:	1.875" - 3.25"
Height:	2.25" - 4.25"
Depth:	.875"

Included Components:	
RAM-HOL-UN7BU	X-Grip®
RAM-B-201U	standard arm
RAM-B-309-7U	brake/clutch base with u-bolts
RAM-HOL-UN7TU	tether

# complete kits



## Handlebar Mount with U-Bolt Base and Universal X-Grip® Phone Cradle

The ability to mount to any rail gives you the ultimate in flexibility for mounting your X-Grip®. Included in this package are two u-bolts that will accommodate rails from .5" to 1.25" in diameter. The base includes black caps to be placed over the exposed ends of the u-bolt and a composite protective insert.

The RAM® X-Grip® has a clean and clever four leg design that sports great holding power without hiding your phone behind foam pads and plastic. The patented grips keep your device in plain view so you can access your GPS or camera. The X-Grip® includes a device tether intended for rugged use.

Part:	RAM-B-149Z-UN10U
U-Bolt metal type:	zinc-coated
Fits Handlebars:	.5" - 1.25" diameter
Included Hardware:	adapter, 2 u-bolts, nuts, cover caps
Ball Size:	1" diameter rubber ball

X-Grip®	Dimensions:
Width:	1.75" - 4.5"
Height:	3.25" - 5.5"
Depth:	.875"

Included Components:	
RAM-HOL-UN10BU	X-Grip®
RAM-B-201U	standard arm
RAM-B-231ZU	u-bolt base
RAM-HOL-UN10TU	tether

## Tough-Claw™ Mount with Universal X-Grip® Phone Cradle

We named it the Tough-Claw™ because it is. By pairing it with an X-Grip®, we enable you to put your phone in quick view even if you want to mount it to a handlebar, crash bar or luggage rack. The Tough-Claw™ can attach to rails up to 1.5" wide.

The RAM® X-Grip® has a clean and clever four leg design that sports great holding power without hiding your phone behind foam pads and plastic. The patented grips keep your device in plain view so you can access your GPS or camera. The X-Grip® includes a device tether intended for rugged use.



Part:	RAM-HOL-UN7-400U
-------	------------------

X-Grip®	Dimensions:
Width:	1.875" - 3.25"
Height:	2.25" - 4.25"
Depth:	.875"

Tough-Claw™ Specs	
Clamping Range (Rail):	.625" - 1.5" diameter

*\*seen in image on page 29*

# complete kits



seen in this photo:  
RAM-HOL-UN7-400U (Tough-Claw™  
mount with X-Grip® phone cradle)

# complete kits



## Twist-Lock™ Suction Cup Mount with Universal X-Grip® Phone Cradle

A mechanical suction seal locks in the mount to any smooth surface and expands your mounting options. When you lock in the suction cup to any glass or non-porous surface, you can feel the strength. Paired with the X-Grip®, this mount looks great on any flat surface.

The RAM® X-Grip® has a clean and clever four leg design that sports great holding power without hiding your phone behind foam pads and plastic. The patented grips keep your device in plain view so you can access your GPS or camera. The X-Grip® includes a device tether intended for rugged use.

Part:	RAM-B-166-UN7U
Ball Size:	1" diameter rubber ball

Included Components:	
RAM-HOL-UN7BU	X-Grip®
RAM-B-201U	standard arm
RAM-B-224-1U	suction cup base
RAM-HOL-UN7TU	tether

X-Grip®	Dimensions:
Width:	1.875" - 3.25"
Height:	2.25" - 4.25"
Depth:	.875"

Specs:	3.3" dia. suction cup
--------	-----------------------

*\*seen in image on page 31*



## Twist-Lock™ Suction Cup Mount with Custom GoPro® HERO Adapter

The RAM® adapter for GoPro® HERO cameras consists of a 1" diameter rubber ball connected to a custom GoPro® adapter. The adapter attaches directly to the under-side of the protective case replacing the factory mounting bracket. This mount connects to the RAM® ball and socket system to dampen vibration and add durability.

Mount this system on any smooth, non-porous surface with the 3.3" wide suction cup base. The mechanical seal locks in the base and keeps your GoPro® stable and secure.

Part:	RAM-B-166-A-GOP1U
Ball Size:	1" diameter rubber ball
Fits:	GoPro® HERO cameras

Included Components:	
RAP-B-202U-GOP1	GoPro® adapter
RAM-B-201U-A	short arm
RAM-B-224-1U	suction cup base

Specs:	3.3" dia. suction cup
--------	-----------------------

# complete kits

**seen in this photo:**

RAM-B-166-UN7U (kit including Twist-Lock™ suction cup base, standard arm, & universal X-Grip® phone cradle)



# complete kits



## LED Spotlight Mount with Medium Tough-Claw™

Our rugged spotlight features a bright and efficient LED bulb with a frosted lens that enables you to brighten up your ATV, UTV or golf cart. The weather-resistant body shields the 30 degree spotlight LED bulb from the elements and yields a wider and brighter range of light. The long cord with standard 12v plugin means you can mount the light virtually anywhere on your vehicle.

The Tough-Claw™ is the perfect mounting base for quick and easy tool-less installation and removal on round, square, odd shaped rails and bars and flat surfaces. The marriage of tool-less removal and a low-profile makes this a must have accessory.

Part:	RAM-B-152-404
Power:	12V DC cigarette plug
Ball Size:	1" diameter rubber ball

Replacement Bulb Part:	RAM-B-152-BULB
Power Cable:	10' coiled w/ male cigarette plug
Hardwire Cable:	12" w/ 2 ring terminals, female cigarette plug
Bulb Specifications:	30-degree spotlight 4500K color temp

Tough-Claw™ Specs	
Clamping Range (Rail):	1" to 1.875" dia.

Included Components:	
RAM-B-152B	spotlight
RAM-B-201U	standard arm
RAP-B-404U	medium Tough-Claw™



## Tough-Claw™ Mount with Self-Leveling Cup Holder

The universal self-leveling drink cup holder has two pivot points, allowing for your drink to always stay upright and never spill. The insulating koozie is included with purchase. The integrated eyelet and hook provide an optional tethering function, securing any small or open container in any harsh environment.

The Tough-Claw™ is the perfect mounting base for quick and easy tool-less installation and removal on round, square, odd shaped rails and bars and flat surfaces. The marriage of tool-less removal and a low-profile makes this must have accessory easy to pack with you wherever you go.

Part:	RAM-B-132-400U
Fits:	Cups, cans, bottles or mugs 2.5" - 3.5" diameter

Tough-Claw™ Specs	
Clamping Range (Rail):	.625" to 1.5" dia.



# complete kits

seen in this photo:  
RAM-B-132-400U  
(Tough-Claw™ mount  
with self-leveling cup  
holder)



# accessories

**seen in this photo:**

RAM-B-231ZU (rail base w/ zinc-coated u-bolt)

RAM-B-273U (threaded stud with 1" ball)

RAM-B-201U-A (short arm x 2)

RAM-HOL-UN7BU (X-Grip® for phones)

RAM-B-202U-GA63 (Garmin Virb™ camera adapter)

RAM-HOL-UN7TU (security tether for phones)





## 🔒 Pin-Lock™ Security Knob and Key for 1" Diameter B Size Arms

The Pin-Lock™ security knob adds tamper resistance and theft deterrence to your B sized mount by replacing your standard knob. The low-profile knob is the perfect accessory to keep your mounted electronic device safe.

Part:	RAP-S-KNOB3U
Fits:	any B size arm



## RAM® X-Grip® Post Caps (4 qty)

It's good to carry spare parts and that's why we've made available extra post caps for our X-Grip® products knowing that the smallest parts can be the hardest to find. The rubber caps protect your electronic device and provide the grip you need to keep it secure.



Part:	RAP-UN-CAP-4U
Fits:	any size X-Grip®



## Threaded Stud with 1" Ball

This 1/4"-20 x 2.25" long stainless steel stud enables you to add an extra ball on the side of your mounting arm. You can also use it as a pass through bolt on a tube or rail. The stud has threads the whole length so you can set it at any depth or connect it to any B sized arm. This enables you to further customize your mounting solution.

Part:	RAM-B-273U
Dimensions:	1/4"-20 x 2 1/4"
Ball Size:	1" diameter rubber ball

*\*seen in image on page 34*



## RAM® Mounts X-Grip® Tether

The X-Grip® tether provides the extra grip to latch your mobile phone or tablet into the X-Grip®. The rubber tether hooks over the edges of your device to hold it tight against the body of the X-Grip® and ensures that regardless of where you're riding, your device will stay where you want it. The tether holds your device securely in place while riding over rough roads or trails.

Part:	Fits:
RAM-HOL-UN7TU	UN7 X-Grip® cradles
RAM-HOL-UN8TU	UN8 X-Grip® cradles
RAM-HOL-UN10TU	UN10 X-Grip® cradles



### How to use the Tether:

1. A hand holds the tether, showing the four circular protrusions.
2. A hand holds the tether, showing the four circular protrusions.
3. A hand holds the tether, showing the four circular protrusions.
4. A hand holds the tether, showing the four circular protrusions.
5. A hand holds the tether, showing the four circular protrusions.
6. A hand holds the tether, showing the four circular protrusions.

# accessories

**seen in this photo:**

RAP-B-354U-TRA1 (track ball with t-bolt attachment)

RAM-B-201U-A (short arm)

RAM-HOL-UN8BU (X-Grip® for 7" tablets)

RAM-HOL-UN8TU (security tether for 7" tablets)



## IntelliSkin™ - Always Protected. Always Connected.

IntelliSkin™ is a protective device case that features an integrated power connector compatible with any GDS™ charging dock. This prevents damage to the device charging port and creates a universal docking platform compatible with any device wrapped with an IntelliSkin™. IntelliSkin™ ruggedizes consumer devices and adds functionality by simplifying the frequent docking and undocking of smartphones and tablets.

- Always charged
- Device protection
- Simplified docking
- Universal power
- Expanded functionality

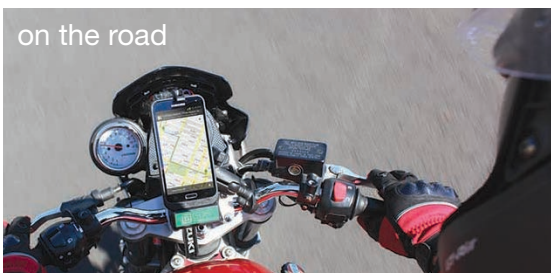

# IntelliSkin™ with GDS Tech™

**seen in this photo:**

RAM-B-231ZU (rail base w/ zinc-coated u-bolt)

RAM-B-201U (standard arm)

RAM-B-238U (diamond base)

RAM-GDS-DOCK-V1U (universal vehicle phone dock with GDS™ Technology for RAM® IntelliSkin™ products)

RAM-GDS-SKIN-SAM14U (IntelliSkin™ for Samsung Galaxy S6)



# IntelliSkin™ with GDS Tech™



**seen in this photo:**

RAM-B-231ZU (rail base w/ zinc-coated u-bolt)

RAM-B-201U (standard arm)

RAM-B-238U (diamond base)

RAM-GDS-DOCK-V1U (universal vehicle phone dock with GDS™ Technology for RAM® IntelliSkin™ products)

RAM-GDS-SKIN-SAM14U (IntelliSkin™ for Samsung Galaxy S6)





# IntelliSkin™ with GDS Tech™

## Universal Vehicle Phone Dock with GDS™ Technology for RAM® IntelliSkin™ Products

The RAM® universal vehicle phone dock with GDS™ Technology is a spring loaded, quick release cradle that offers a secure fit with easy access to the mounted phone or phablet. This docking station is compatible with any phone or phablet wrapped in IntelliSkin™.



Model:	RAM-GDS-DOCK-V1U
Hole Pattern:	2 holes, 1.912" center to center matches cross section of the AMPs hole pattern
Fits:	any phone in an IntelliSkin™
Included Hardware:	nuts & bolts



## IntelliSkin™ with GDS™ Technology for the Samsung Galaxy S5

Our phones have quickly become our GPS units, cameras, diagnostic tools and music players. Keep them charged and protected with IntelliSkin™. This custom-fit case integrates the charging connector and adds docking contacts to extend the life of your device.



Part:	RAM-GDS-SKIN-SAM7U
Fits:	Samsung Galaxy S5



## IntelliSkin™ with GDS™ Technology for the Samsung Galaxy S6

Our phones have quickly become our GPS units, cameras, diagnostic tools and music players. Keep your Samsung Galaxy S6 charged and protected with this custom-fit case which integrates the charging connector and adds docking contacts to extend the device's life.



Part:	RAM-GDS-SKIN-SAM14U
Fits:	Samsung Galaxy S6





## IntelliSkin™ with GDS™ Technology for the iPhone 6 and 6s

This protective sleeve for the iPhone 6 and 6s featuring GDS™ Technology brings drop protection to your device and features an integrated connector which is molded directly into the skin. The GDS™ connector standardizes the charging interface.

Part:	RAM-GDS-SKIN-AP9
Fits:	iPhone 6 and 6s

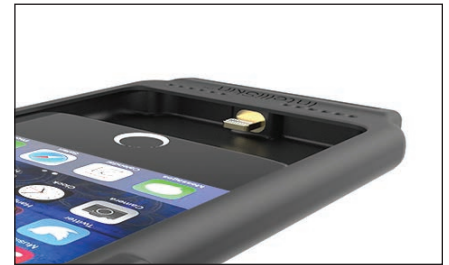

## IntelliSkin™ with GDS™ Technology for the iPhone 6 Plus and 6s Plus

This protective sleeve for the iPhone 6 Plus and 6s Plus featuring GDS™ Technology brings drop protection to your device and features an integrated connector which is molded directly into the skin. The GDS™ connector standardizes the charging interface.

Part:	RAM-GDS-SKIN-AP10
Fits:	iPhone 6 Plus and 6s Plus



## GDS™ 2-Port USB Cigarette Charger

The GDS™ 2-Port USB cigarette charger will charge two devices at once, including the latest generation Apple and Samsung devices, while on the road. The low-profile design fits easily in your dash without getting in the way of other controls within the vehicle. The indicator light lets you know that the charger is fully plugged in and that your device is charging. The 2.4A output assures your devices will charge quickly and efficiently.



Part:	RAM-GDS-CHARGE-USB2HCIG
Input Range:	12-24 VDC
Output Voltage:	5 VDC
Output Current:	2.4A per USB port
Power Output:	24W
Output Connector Type:	2 female USB type A



# IntelliSkin™ with GDS Tech™

## 10' Power Cord with Female Cigarette Plug

If your machine does not have a 12v charger, we make it easy to install one. The 10' long non-coiled cable with two ring terminals is designed to route to either the vehicle battery or a fuse panel for a permanent hard-wire power installation.



Part:	RAM-CIG-F-10
Cable Length:	10'
Input Connector:	two .31 ID ring terminals
Output Connector:	female cigarette plug



## GDS™ Step Down Converter Charger with Male Micro-B USB Connector

This is the ideal solution for providing power to any 5V device on your ride. This charger features a male micro-B USB connector which can connect directly to your GDS™ dock or USB device. This will charge most popular 5V devices.

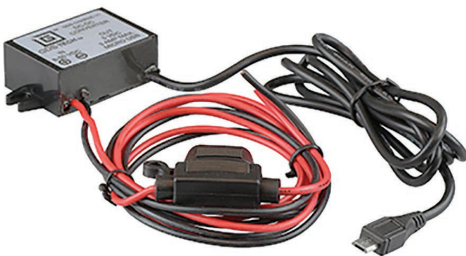

Part:	RAM-GDS-CHARGE-V1
Input Range:	10-50 VDC
Output Voltage:	5 VDC
Output Current:	3A max
Input Cable Length:	1.2 meters
Output Cable Length:	1.2 meters
Output Connector Type:	male micro-B USB



## GDS™ Step Down Converter Charger with Female USB Type A Connector

This is the ideal solution for providing power to any 5V device on your ride. This charger features a female USB-A connector which can connect directly to any standard USB cable. This will charge most popular 5V devices.



Part:	RAM-GDS-CHARGE-V2
Input Range:	10-50 VDC
Output Voltage:	5 VDC
Output Current:	3A max
Input Cable Length:	1.2 meters
Output Cable Length:	1.2 meters
Output Connector Type:	female USB type A



# all products

The following pages showcase a range of products we offer for the powersports industry. To see if a specific part fits your ride, please see our motorcycle wizard at [www.rammount.com](http://www.rammount.com)











# all products







seen in this photo:  
RAM-B-346U (brake/clutch reservoir cover)  
RAM-B-201U (standard arm)  
RAP-300-1U (Magnetic Power Plate™ III for  
radar detectors)





# bases





RAM-B-231ZU	RAM-231ZU	RAM-B-231U	RAM-B-231CHU
Zinc-coated u-bolt base fits .5"-1.25" rails, 1" ball	Zinc-coated u-bolt base fits .5"- 1.25" rails, 1.5" ball	Stainless steel u-bolt base fits .5" to 1" rails, 1" ball	Chrome base w/ stainless steel u-bolt fits .5"-1.25" rails, 1" ball
			

RAM-231U	RAM-B-231-1U	RAM-B-231-1CHU	RAM-231-1U
Stainless steel u-bolt base fits .5"-1" rails, 1.5" ball	Stainless steel u-bolt base fits 1"-1.25" rails, 1" ball	Chrome base w/ stainless steel u-bolt fits 1"-1.25" rails, 1" ball	Stainless steel u-bolt base fits 1"-1.25" rails, 1.5" ball
			





RAM-B-231Z-2U	RAM-B-231Z-2NUBU	RAM-B-252U	RAM-B-272U
Rail base w/ zinc-coated u-bolt fits .5"-1.25 rails & ATV/UTV strap fits 1.57"-3.15" bars, 1" ball	Strap base fits 1.57"-3.15" bars, 1" ball	Flat base 2.25" long x .875" wide x .2" thick w/ 11mm hole, 1" ball	Angled base 1.1875" long x .75" wide x .2" thick w/ 9mm hole, 1" ball
			





RAM-B-309-7U	RAM-B-309-1U	RAM-B-309-1CHU	RAM-B-309-2U
Brake/clutch reservoir base for hole centers .94"-1.58" wide, zinc-coated u-bolts fit .5"-1.25" rails, 1" ball	Brake/clutch reservoir base for hole centers .94"-1.58" wide, 1" ball	Chrome brake/clutch reservoir base for hole centers .94"-1.58" wide, 1" ball	Brake/clutch reservoir base for hole centers .94"-1.58" wide, 2 qty 1" balls
			





RAM-B-309-2CHU	RAM-B-367U	RAM-B-342U	RAM-B-346U
Chrome brake/clutch reservoir base for hole centers .94"-1.58" wide, 2 qty 1" balls	Handlebar clamp base w/ 1.25 mm thread pitch bolts sizes M8x55, M8x60, M8x65, 1" ball	Base for fork stems 12, 14, 16, 18 & 20mm (.5", .55", .63", .71" & .79") wide, 1" ball	Brake/clutch reservoir cover w/ M4x20, M4x30, M4x35 screws washers & nylon spacers, 1" ball
			

RAM-B-345U	RAM-B-410U	RAM-B-411U	RAP-B-379-HA1U
Brake/clutch reservoir cover w/ M4x20, M4x30, M4x35 screws, washers & nylon spacers, 1" ball	Gas tank bracket for Honda, Suzuki, Yamaha, Victory & KTM, M6x25, M5x16, M5x20, M5x25, M5x35, M5x45 & screws & washers, 1" ball	Gas tank bracket for BMW & Kawasaki, M5x25, M5x40 screws & washers, 1" ball	Mirror post base with 1/4"-20 x 1" thread, female blind barrel nut & nylon washer for Harley-Davidson bikes, 1" ball
			

# bases





RAP-B-400U	RAP-400U	RAP-B-404U	RAP-404U
Small Tough-Claw™ base fits .625"-1.5" rails, 1" ball	Small Tough-Claw™ base fits .625"-1.5" rails, 1.5" ball	Medium Tough-Claw™ base fits 1"-1.875" rails, 1" ball	Medium Tough-Claw™ base fits 1"-1.875" rails, 1.5" ball
			

RAP-B-401U	RAP-401U	RAM-B-408-37-62U	RAM-B-408-75-1U
Large Tough-Claw™ base fits 1"-2.25" rails, 1" ball	Large Tough-Claw™ base fits 1"-2.25" rails, 1.5" ball	Torque™ fits .375"-.625" rails, sizing inserts, 1" ball	Torque™ fits .75"-1" rails, sizing inserts, 1" ball
			

RAM-408-75-1U	RAM-B-408-112-15U	RAM-408-112-15U	RAM-B-360U
Torque™ fits .75"-1" rails, sizing inserts, 1.5" ball	Torque™ fits 1.125"-1.5" rails, sizing inserts, 1" ball	Torque™ fits 1.125"-1.5" rails, sizing inserts, 1.5" ball	Twist and Tilt™ pivot base w/ M10x1.25x20, M10x1.25x40, M8x1.25x20, M8x1.25x40 screws, 1" ball
			



# bases





RAM-B-108BU	RAM-108BU	RAM-271U-12	RAM-271U-2
V-shaped base fits 1"-2.1" rails, 1" ball	Strap base fits 1"-2.1" rails, 1.5" ball	Clamp base fits 1.25"-1.875" rails, 1.5" ball	Clamp base fits 2"-2.5" rails, 1.5" ball
			





RAM-B-224-1U	RAM-B-349U	RAM-B-349-1U	RAP-B-378U
3.3" diameter suction cup, 1" ball	Base w/ M10 x 1.25mm thread pitch, 14.5mm dia. flange, 10.15mm thread length, 1" ball	Base w/ M10 x 1.5mm thread pitch, 14.3mm dia. flange, 10.5mm thread length, 1" ball	Flex adhesive 2.5" diameter base, 1" ball
			







seen in this photo:  
 RAM-B-231Z-2NUBU (strap base)  
 RAM-B-201U (standard arm)  
 RAM-HOL-UN10BU (X-Grip® for large phones)  
 RAM-HOL-UN10TU (security tether for large phones)

# arms





RAM-B-201U-A	RAM-B-201-ACHU	RAM-B-201U	RAM-B-201CHU
Short, 2.38" arm for 1" balls	Chrome short, 2.38" arm for 1" balls	Medium, 3.69" arm for 1" balls	Chrome medium, 3.69" arm for 1" balls
			





RAM-B-201U-C	RAM-201U-B	RAM-201-BCHU	RAM-201U
Long, 6" arm for 1" balls	Short, 3.5" arm for 1.5" balls	Chrome short, 3.5" arm for 1.5" balls	Medium, 5.625" arm for 1.5" balls
			

RAM-201U-D	RAP-B-200-2U	RAP-B-200-12U	RAP-BC-201U
Long, 9.125" arm for 1.5" balls	Multi pivot, 6.25" arm for 1" balls	Swivel, 4.23" arm w/ 360 degrees of rotation for 1" balls	Swivel, 5.25" arm w/ 360 degrees of rotation, connects 1" to 1.5" balls
			



# camera adapters

RAP-B-202U-GOP1	RAM-B-202AU	RAP-B-202AU	RAM-202AU
Adapter for GoPro® HERO cameras, 1" ball	2.5" round base, 1/4"-20 x .25" threaded post, 1" ball	Composite 2.5" round base, 1/4"-20 x .25" threaded post, 1" ball	2.5" round base, 1/4"-20 x .25" threaded post, 1.5" ball
			

RAM-202CU	RAP-B-379U-252025	RAM-B-237U	RAM-237U
2.5" round base, 3/8"-16 x .375" threaded post, 1.5" ball	Tough-Ball™, 1/4"-20 x .25" threaded post, 1" ball	1/4"-20 x .25" threaded post, 1" ball	1/4"-20 x .25" male threaded post, 1.5" ball
			

RAP-B-366U	RAP-366U	RAM-B-202U-GA62	RAM-B-202U-GA63
Composite 1.26" round base, 1/4"-20 x .25" threaded post, 1" ball	Composite 1.26" round base, 1/4"-20 x .25" threaded post, 1.5" ball	Adapter for Garmin VIRB™ factory mounts, 1" ball	Adapter for Garmin VIRB™ camera, 1" ball
			

# camera adapters

RAM-B-236U	RAM-B-236-SEC1U
3/8"-16 x .5" threaded post w/ split lock washer, 5/8" flange & flats for wrench, 1" ball	3/8"-16 x .4" threaded post, 5/8" flange, 1" ball
	



seen in this photo:  
RAM-B-400U (small Tough-Claw™)  
RAP-B-200-2U (multi pivot arm)  
RAP-B-379U-252025 (Tough-Ball™)

# cradle/device adapter

## Adapter Guide: Select your cradle adapter

We give you the choice to fully customize your mounting system. Each component is modular and as part of building the perfect solution for your needs, you will need to choose a cradle adapter that will mount to your cradle and connect to the arm of your choice. Select from diamond or round ball adapters.

**Round Base,  
1" ball**



Part: RAM-B-202U

**Chrome Round  
Base, 1" ball**



Part: RAM-B-202CHU

**Round Base,  
1.5" ball**



Part: RAM-202U

**Diamond Base,  
1" ball**



Part: RAM-B-238U

**Chrome Diamond  
Base, 1" ball**



Part: RAM-B-238CHU

<p><b>RAM-B-202U</b></p>	<p><b>RAM-B-202CHU</b></p>	<p><b>RAM-202U</b></p>
<p>2.5" round base, 1.5" x 1.188" AMPs hole pattern, 3 holes at 120 degrees, 1" ball</p>	<p>Chrome, 2.5" round base, 1.5" x 1.188" AMPs hole pattern, 3 holes at 120 degrees, 1" ball</p>	<p>2.5" round base, 1.5" x 1.188" AMPs hole pattern, 3 holes at 120 degrees, 1.5" ball</p>
		
<p><b>RAM-B-347U</b></p>	<p><b>RAM-B-238U</b></p>	<p><b>RAM-B-238CHU</b></p>
<p>2"l x 1.7"w square base, 1.5" x 1.188" spacing matches AMPs pattern, 1" ball</p>	<p>2.43"l x 1.31"w diamond base, 2 holes 1.912" center to center, matches cross section of the AMPs pattern, 1" ball</p>	<p>Chrome, 2.43"l x 1.31"w diamond base, 2 holes 1.912" center to center, matches cross section of the AMPs pattern, 1" ball</p>
		

# cradles

<p><b>RAM-HOL-UN7BU</b></p>	<p><b>RAM-HOL-UN10BU</b></p>	<p><b>RAM-HOL-UN8BU</b></p>	<p><b>RAM-HOL-PD3U</b></p>
<p>X-Grip® for phones, 1.875" min - 3.25" max width, .875" depth, 1" ball</p>	<p>X-Grip® for larger phones, 1.75" min - 4.5" max width, .875" depth, 1" ball</p>	<p>X-Grip® for 7"-8" tablets, 2.5" min - 5.75" max width, .875" depth, 1" ball</p>	<p>Spring loaded cradle, height range 4.75"-6.25", width range 2.25"-3.25"</p>
			
<p><b>RAM-HOL-AP18U</b></p>	<p><b>RAM-HOL-AP19U</b></p>	<p><b>RAM-HOL-AP14U</b></p>	<p><b>RAM-HOL-AP20U</b></p>
<p>Form-fitted cradle for the iPhone 6 &amp; 6s w/o case, skin, or sleeve</p>	<p>Form-fitted cradle for the iPhone 6 Plus &amp; 6s Plus w/o case, skin, or sleeve</p>	<p>EZ-Roll'r™ cradle for iPad mini 1-3 w/o case, skin, or sleeve</p>	<p>EZ-Roll'r™ cradle for iPad mini 4 w/o case, skin, or sleeve</p>
			
<p><b>RAM-HOL-UN4U</b></p>	<p><b>RAM-GDS-DOCK-V1U</b></p>	<p><b>RAM-B-132BU</b></p>	<p><b>RAM-HOL-GUN1U</b></p>
<p>Universal Finger-Grip™ phone/radio cradle</p>	<p>GDS™ vehicle phone dock for phones in an IntelliSkin™</p>	<p>Drink cup holder w/ koozie, 1" ball</p>	<p>Gun holster bracket w/ AMPs hole pattern</p>
			

RAM-HOL-GA12U	RAM-HOL-GA21U	RAM-HOL-GA25U	RAM-HOL-GA31U
Cradle for the Garmin Astro® 220, GPS 60™, GPSMAP® 60, 60C, 60CS, 60CSx & 60Cx	Cradle for the Garmin nüvi® 300, 310, 350, 360 & 370	Cradle for the Garmin nüvi® 200W, 205W, 250W, 255W, 260W, 265W, 265WT, 285WT, 2455LMT, 2475LT, 2495LMT & 465T	Cradle for the Garmin Approach® G5, Oregon® 200, 300, 400, 450, 550, 600 & 650
			
RAM-HOL-GA40U	RAM-HOL-GA41U	RAM-HOL-GA43U	RAM-HOL-GA46U
Cradle for the Garmin GPSMAP® 78, 78s & 78sc	Cradle for Garmin Astro® 320, GPSMAP® 62 Series & GPSMAP® 64 Series	Cradle for the Garmin dēzl™ 560LMT & 560LT	Cradle for Garmin Montana® 600, 650, & 650t
			
RAM-HOL-GA47U	RAM-HOL-GA57U	RAM-HOL-GA66LU	RAM-HOL-GA67U
Cradle for Garmin Rino® 610, 650 & 655t	Cradle for the Garmin nüvi® 2557LMT, 2577LT, 2597LMT & 2598LMTHD	Locking cradle for the Garmin fleet™ 660/670	Cradle for the Garmin nüvi® 65, 66, 67, 68
			

RAM-HOL-TO9U	RAM-HOL-TO10U	RAM-HOL-TO11U	RAM-HOL-DEL1U
Cradle for the TomTom GO 740	Cradle for TomTom Start 55, Start 55M, Start 55TM, XXL 535T, XXL 540 Series, XXL 540 WTE Series & XXL 550 Series	Cradle for the TomTom 2535 M LIVE & 2535 TM WTE	Cradle for DeLorme Earthmate PN-20, PN-30, PN-40, PN-60 & PN-60w
			
RAM-HOL-DEL2U	RAM-HOL-MA9U	RAM-HOL-MA10U	RAM-HOL-MA12U
Cradle for DeLorme inReach™	Cradle for the Magellan® Triton 200, 300, 400 & 500	Cradle for the Magellan® MobileMapper™ 6, Triton 1500 & 2000	Cradle for the Magellan® Maestro™ 4200, 4210, 4220 & 4250
			
RAM-HOL-MA14U	RAM-HOL-MA15U	RAM-HOL-SPO2U	RAM-HOL-SPO3U
Cradle for the Magellan® eXplorist® 510, 610 & 710	Cradle for the Magellan® eXplorist® GC, 110, 310, 350H	Cradle for the SPOT IS™ Satellite GPS Messenger & Satellite GPS Messenger	Cradle for the SPOT Connect™ & Satellite Communicator
			



RAM-HOL-SPO4U	RAM-HOL-AQ3U	RAM-HOL-AQ2U	RAM-HOL-AQ6U
Cradle for SPOT Gen3™	AQUA BOX® sealed enclosure, fits devices 2.38"w x 4.63"h x 1.13"d	AQUA BOX® sealed enclosure, fits devices 2.88"w x 5.75"h x 1.188"d	AQUA BOX® sealed enclosure, fits devices 6"w x 4"h x 1.75"d
			
RAM-HOL-AQ1U	RAM-HOL-AQ7-1CU	RAM-HOL-AQ7-2-15CU	RAM-HOL-AQ7-2CU
AQUA BOX® sealed enclosure, fits devices 3.5"w x 8.43"h x 2.25"d	AQUA BOX® Pro 10 sealed enclosure, fits devices 2.46"w x 4.58"h x .47"d	AQUA BOX® Pro 20 i5 sealed enclosure, fits devices 2.33"w x 4.9"h x .35"d	AQUA BOX® Pro 20 sealed enclosure, fits devices 2.8"w x 5.38"h x .55"d
			

seen in this photo:  
 RAM-B-231ZU (rail base w/ zinc-coated u-bolt)  
 RAM-B-201U (standard arm)  
 RAM-HOL-SPO4U (Cradle for SPOT Gen3™)



# complete kits

RAM-B-176-A-UN7U	RAM-B-174-UN7U	RAM-B-149Z-UN7U
<p>Fork stem base for stems 12, 14, 16, 18, 20 &amp; 28mm (.5", .55", .63", .71", .79", 1.1") wide, short arm, X-Grip® for phones</p>	<p>Brake/clutch reservoir base for hole centers .94"-1.58" wide, zinc-coated u-bolts fit .5"-1.25" rails, standard arm, X-Grip® for phones</p>	<p>Zinc-coated u-bolt fits .5"-1.25" rails, standard arm, X-Grip® for phones</p>
		
RAM-HOL-UN7-400U	RAM-B-166-UN7U	RAM-B-408-37-62-UN7U
<p>Small Tough-Claw™ base fits .625"-1.5" rails, X-Grip® for phones</p>	<p>3.3" suction cup base, standard arm, X-Grip® for phones</p>	<p>Torque™ fits .375"-.625" rails, sizing inserts, standard arm, X-Grip® for phones</p>
		

# complete kits

RAM-B-408-75-1-UN7U	RAM-B-408-112-15-UN7U	RAP-B-236-A-UN7U
Torque™ fits .75"-1" rails, sizing inserts, standard arm, X-Grip® for phones	Torque™ fits 1.125"-1.5" rails, sizing inserts, standard arm, X-Grip® for phones	3/8"-16 x .5" threaded post w/ split lock washer, short arm, X-Grip® for phones
		
RAM-B-149Z-UN10U	RAM-HOL-UN10-400U	RAM-B-408-37-62-UN10U
Zinc-coated u-bolt fits .5"-1.25" rails, standard arm, X-Grip® for larger phones	Small Tough-Claw™ base fits .625"-1.5" rails, X-Grip® for larger phones	Torque™ fits .375"-.625" rails, sizing inserts, standard arm, X-Grip® for larger phones
		





# complete kits





RAM-B-408-75-1-UN10U	RAM-B-408-112-15-UN10U	RAM-B-149Z-A-GOP1U
Torque™ fits .75"-1" rails, sizing inserts, standard arm, X-Grip® for larger phones	Torque™ fits 1.125"-1.5" rails, sizing inserts, standard arm, X-Grip® for larger phones	Zinc-coated u-bolt fits .5"-1.25" rails, short arm, adapter for GoPro® HERO cameras
		
RAP-B-400-GOP1U	RAP-B-404-GOP1U	RAM-B-166-A-GOP1U
Small Tough-Claw™ base fits .625"-1.5" rails, standard arm, adapter for GoPro® HERO cameras	Medium Tough-Claw™ base fits 1"-1.875" rails, standard arm, adapter for GoPro® HERO cameras	3.3" suction cup base, short arm, adapter for GoPro® HERO cameras
		



# complete kits

RAM-B-108-GOP1U	RAM-B-152-231Z-2	RAM-B-152-404
<p>V-shape base fits 1"-2.1" rails, standard arm, adapter for GoPro® HERO cameras</p>	<p>Strap base fits 1.57"-3.75" rails, standard arm, LED spotlight</p>	<p>Medium Tough-Claw™ base fits 1"-1.875" rails, standard arm, LED spotlight</p>
		
RAM-B-132-400U	RAM-B-224-1-366U	RAM-B-108B-A-366U
<p>Small Tough-Claw™ base fits .625"-1.5" rails, self-leveling drink holder w/ koozie</p>	<p>3.3" suction cup base, standard arm, 1/4"-20 x .25" camera adapter</p>	<p>V-shaped base fits 1"-2.1" rails, short arm, 1/4"-20 x .25" camera adapter</p>
		





# accessories

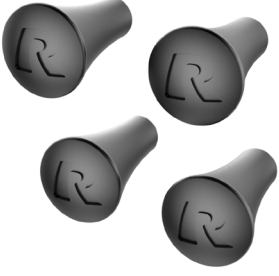



RAP-S-KNOB3U	RAP-S-KNOB3-4U	RAP-S-KNOB3-5U	RAP-S-KNOB3-6U
Mixed combination security knob for B sized arms w/ 1" diameter balls	4 Pin-Lock™ security knob for B sized arms w/ 1" diameter balls	5 Pin-Lock™ security knob for B sized arms w/ 1" diameter balls	6 Pin-Lock™ security knob for B sized arms w/ 1" diameter balls
			



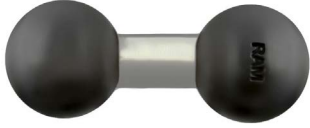

RAP-S-KNOB3-7U	RAP-S-KNOB5U	RAP-S-KNOB5-4U	RAP-S-KNOB5-5U
7 Pin-Lock™ security knob for B sized arms w/ 1" diameter balls	Mixed combination security knob for C sized arms w/ 1.5" diameter balls	4 Pin-Lock™ security knob for C sized arms w/ 1.5" diameter balls	5 Pin-Lock™ security knob for C sized arms w/ 1.5" diameter balls
			

RAP-S-KNOB5-6U	RAP-S-KNOB5-7U	RAM-KNOB3LU	RAP-UN-CAP-4U
6 Pin-Lock™ security knob for C sized arms w/ 1.5" diameter balls	7 Pin-Lock™ security knob for C sized arms w/ 1.5" diameter balls	Security knob w/ keys for B sized arms w/ 1" diameter balls	4 qty X-Grip® replacement post caps
			

# accessories





RAM-B-273U	RAM-HOL-UN7TU	RAM-HOL-UN10TU	RAM-HOL-UN8TU
1/4"-20 x 2 1/4" threaded stud, 1" ball	Tether for UN7 X-Grip® cradles	Tether for UN10 X-Grip® cradles	Tether for UN8 X-Grip® cradles
			

RAM-B-152B	RAM-B-152-BULB	RAM-B-230U	RAP-300-1U
LED spotlight, 1" ball	Replacement LED spotlight bulb	Double 1" diameter ball adapter	Magnetic Power Plate™ III for radar detectors
			





RAM-B-309-3U	RAM-MAG-1U	RAM-HOL-AQ7-2-15LENSU	RAM-HOL-AQ7-2LENSU
Brake/clutch reservoir adapter for RAM-B-309-1CHU, 1" ball	Screen magnifier, 2" x 4" with 2x zoom	Replacement lens for AQUA BOX PRO® 20 I5	Replacement lens for AQUA BOX PRO® 20
			

# IntelliSkin™ with GDS Tech™







RAM-GDS-DOCK-V1U	RAM-GDS-DOCK-D1U	RAM-GDS-DOCK-D2U	RAM-GDS-AD1U
GDS™ vehicle phone dock for phones in an IntelliSkin™	Desktop Dock Pro Charger with GDS™ Technology for RAM® IntelliSkin™ products	Desktop Dock Charger with GDS™ Technology for RAM® IntelliSkin™ products	Snap-Con™ GDS™ to Micro USB 2.0 adaptor
			

RAM-GDS-SKIN-SAM7U	RAM-GDS-SKIN-SAM14U	RAM-GDS-SKIN-AP9	RAM-GDS-SKIN-AP10
GDS™ IntelliSkin™ for Samsung Galaxy S5	GDS™ IntelliSkin™ for Samsung Galaxy S6	GDS™ IntelliSkin™ for iPhone 6 & 6s	GDS™ IntelliSkin™ for iPhone 6 Plus & 6s Plus
			

RAM-GDS-CHARGE-USB2HCIG	RAM-CIG-F-10	RAM-GDS-CHARGE-V1	RAM-GDS-CHARGE-V2
GDS™ 2-port USB cigarette charger, 5V 2.4A per port	10' hardwire power cord w/ female cigarette plug	GDS™ step down converter charger with male Micro-B USB connector	GDS™ step down converter charger with female USB Type A connector
			



# IntelliSkin™ with GDS Tech™

RAM-GDS-CAB-MUSB2-1	RAM-GDS-CAB-MUSB290-1	RAM-GDS-CAB-MUSB3-1	RAM-GDS-CHARGE-USB2W
GDS™ USB 2.0 straight cable, 1.2 meters long	GDS™ USB 2.0 90-degree cable, 1.2 meters long	GDS™ USB 3.0 cable, 1.2 meters long	GDS™ 2-port USB wall charger, 5V 2.4A per port
			

RAM-GDS-CHARGE-USB6
GDS™ 6-port USB charger





seen in this photo:  
 RAM-GDS-SKIN-SAM14U (GDS™ IntelliSkin™ for Samsung Galaxy S6)  
 RAM-GDS-SKIN-AP7 (GDS™ IntelliSkin™ for Apple iPad mini 4)  
 RAM-GDS-DOCK-D2U (Desktop Dock Charger with GDS™ Technology for RAM® IntelliSkin™ products)

# the shape that started it all

RAM® Double Socket Arms offer a distinctive Hourglass Shape® that is designed to provide optimal performance for most any mounting application. They are recognized globally for the strength and flexibility they offer.

The unique RAM® Mount system offers a full line of interchangeable mounting bases, extensions, device adapters and accessories to secure your gear where you want it.

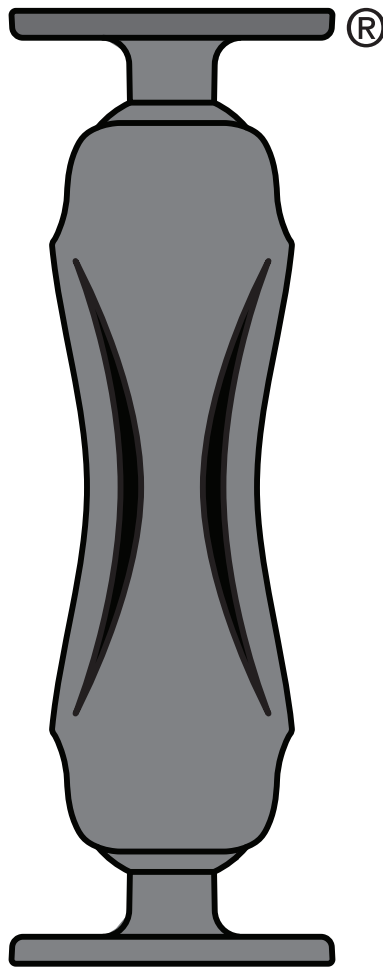
RAM® Mounts are guaranteed for life and are proudly manufactured in Seattle, Washington, USA. See all of the innovative products and solutions RAM® Mounts manufactures at [rammount.com](http://rammount.com).



The RAM® Hourglass Shape® of the Double Socket Arms is a registered trademark of National Products Inc.

**RAM® Mounts is a division of National Products Inc.**

8410 Dallas Avenue South  
Seattle, WA 98108  
Phone: 800.497.7479  
sales@rammount.com  
rammount.com

Lifetime Warranty

Patents and Trademarks  
[www.rammount.com/ip](http://www.rammount.com/ip)

National Products Inc. would like to thank the following:

Hinshaw's Motorcycle Store  
CycoActive  
Indian-Victory Motorcycles of Auburn  
I-90 Motorsports  
Long Bach Nguyen  
MotoLara  
Eastside Harley Davidson  
Trail Systems  
Adventure Mirror





**RAM**<sup>®</sup>  
**MOUNTS**

Contact us

[sales@rammount.com](mailto:sales@rammount.com)  
1-800-497-7479  
206-763-8361

Join our community



RAM<sup>®</sup> Mounts

Valued Partner

